



CATALOGUE

AEP



CAGE
PERFORATED
LADDER

The Integrity of Successful &
Working Perfectly





PRODUCT

Cage

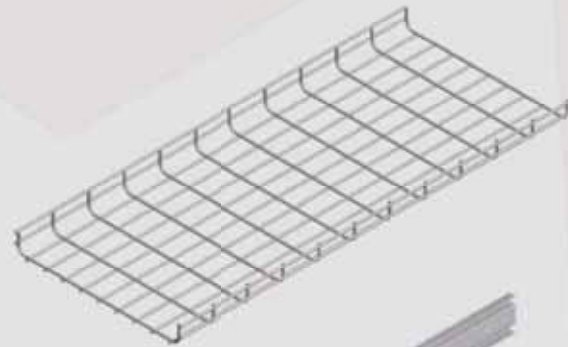

Ladder W

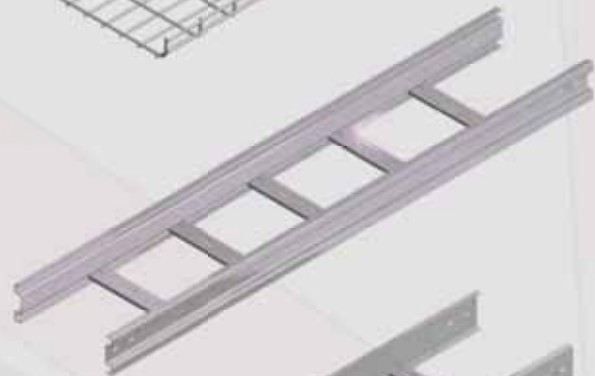

Ladder U



Tray U

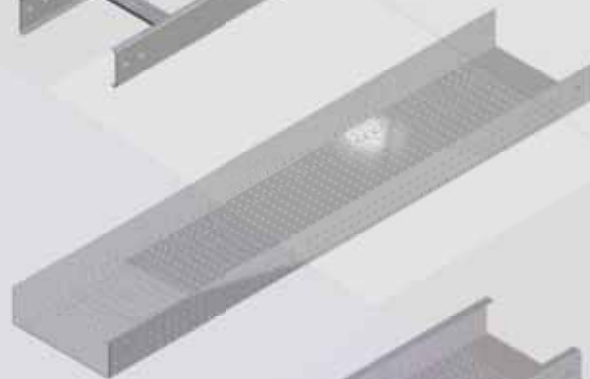

Tray C

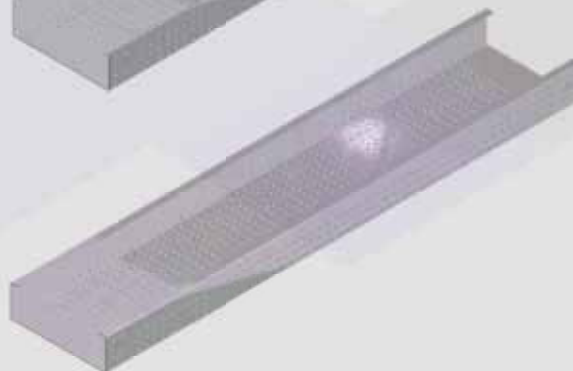



PRODUCT

Cage

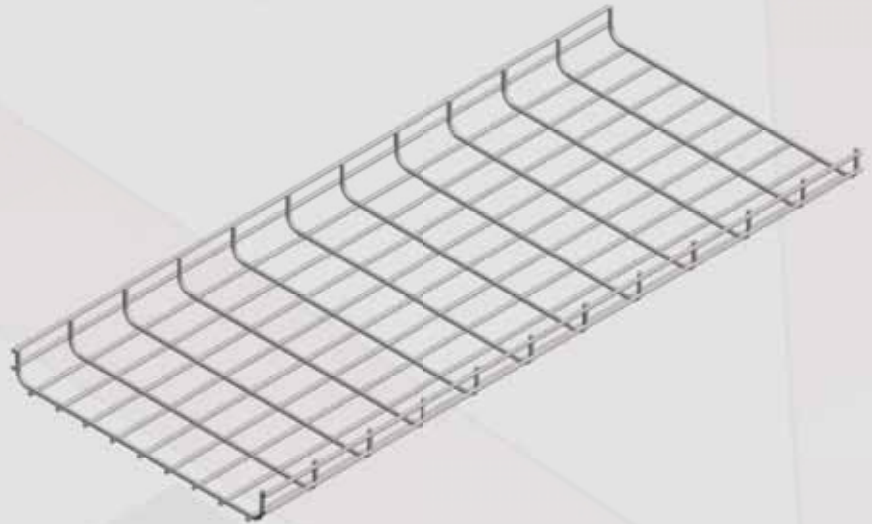

Cross Cage



Elbow Cage



IR Cage

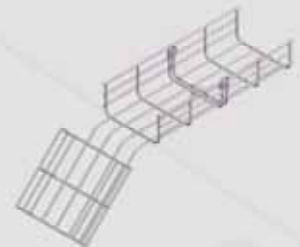

OR Cage



Reducer Cage



Tee Cage



Joiner U20



Hanger Fastener



PRODUCT

Ladder U

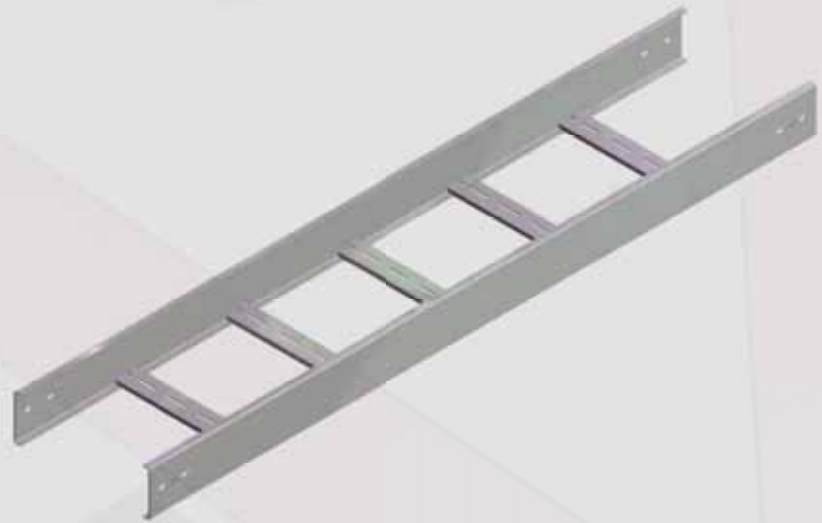

Cross Ladder U

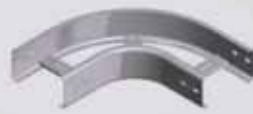

Elbow Ladder U



IR Ladder U



OR Ladder U



Reducer Ladder U



Tee Ladder U



Jointing Ladder U



PRODUCT

Ladder W



Cross Ladder W



Elbow Ladder W



IR Ladder W



OR Ladder W



Reducer Ladder W



Tee Ladder W



Jointing Ladder W



PRODUCT

Tray C

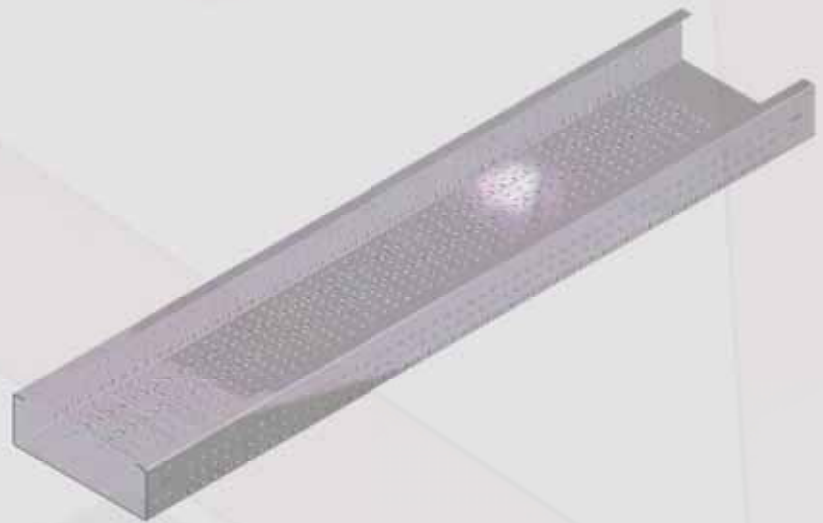

Cross Tray C



Elbow Tray C



IR Tray C



OR Tray C



Reducer Tray C



Tee Tray C



Jointing Tray C



PRODUCT

Tray U

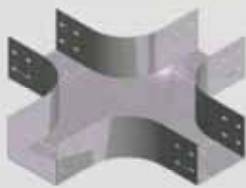
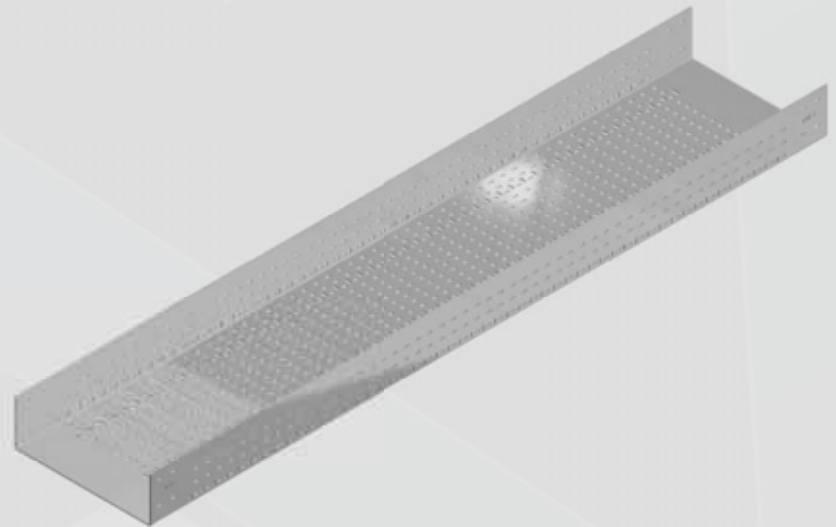

Cross Tray U



Elbow Tray U



IR Tray U



OR Tray U



Reducer Tray U



Tee Tray U



Jointing Tray U



PRODUCT

Accessories



Cover Clip



Cover



End Plate



Hanger Beam



Bolt & Nut



Bracket Mounting

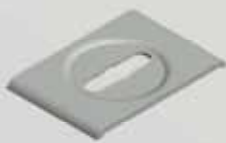

Clamp U40

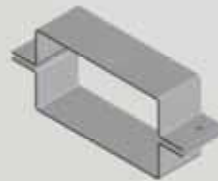

Cover Clamp



Dinabolt



Dinaset



Elbow Bracket



Hanger Rod



Hold Down Clamp



Ring



SPEKIFIKASI

CAGE CABLE

Base Material	:	Drawn Wire & Stainless Steel SS 304
Thick base material	:	W50 Up to W400 ϕ Wire 5mm W500 Up to W600 ϕ Wire 6mm
Material length	:	3000mm, accessories length diverse

TRAY & LADDER

Base Material	:	Black Plat (Hot rolled coil plate/ SPHC)
Thick base material	:	1.8 mm / 2 mm
Material length	:	3000 mm, accessories length diverse

FINISHING

1. Standard finishing for tray, ladder & cage are :
Elektro Plating

Girth	:	Minimum 11 microns
Color	:	Silver dop/ dull grey

2. Standing finishing for tray, ladder & cage are :
Hot Dip Galvanize

Girth	:	Minimum 65 microns
Color	:	Silver dop/ dull grey
Standard Hot dip	:	SNI ISO 9001 : 2008 / QSC 01432

3. Finishing Powder Coating can be ordered specifically.

Type of Goods	Min Width. (mm)	Max Width. (mm)	Height (mm)
Tray type C	50	900	100 & 50
Tray type U	50	1000	100 & 50
Ladder type W	100	1200	100
Ladder type U	100	1200	100 & 50
Cable Cage	50	600	100 & 50



PRODUCT AEP

Product AEP (Cage, Ladder & Perforated) is a product produced by PT. ADHIWIRA ELEKTRIKATAMA PERKASA that offers benefits or advantages in the appeal of other products (traditional).

AEP come to be a part in the development in Indonesia to produce a product that can provide solutions for the electrical wiring and telecommunications.

AEP has always been committed to continue to provide a good quality of the product which is already tested and proven products have a place in the field of AEP industry cable tray especially among contractor in the field of mechanical and electrical.

ADVANTAGES

- Quick installation System and an easy Assembly
- Are strong and lightweight. This is because products derived from high quality raw materials and pass the appropriate standard finishing prosses.
- Fireproof
- Not broken easily
- Products AEP (Cage, Ladder, Perforated Type U) will provide air circulation so that it will always keep the wired network in a cold circumstans and makes it easy for cable maintenance.

SERVICE

AEP is committed to continue to provide good service to consumers by providing quality products at competitive prices and backed by prompt and proper delivery (on schedule).



CAGE CABLE DISTANCE

Cage Dimention

Standard length 3000mm
Hot dip Galvanized, Elektro Platting and Powder Coating

Distance A in mm

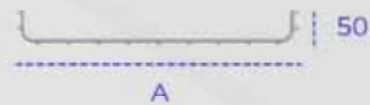
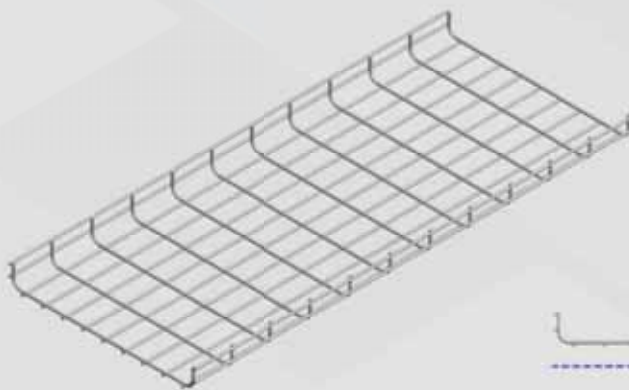

50
100
150
200
300
400
500
600

Cage Dimention

Standard length 3000mm
Hot dip Galvanized, Elektro Platting and Powder Coating

Distance A in mm

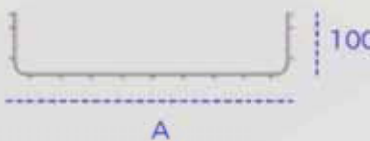
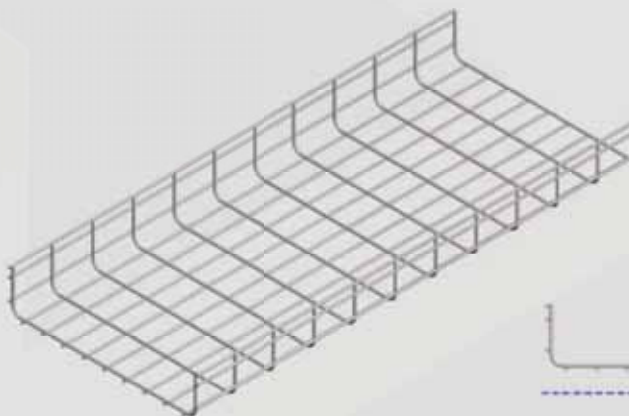

100
150
200
300
400
500
600



INSTALLATION POWER

Cage

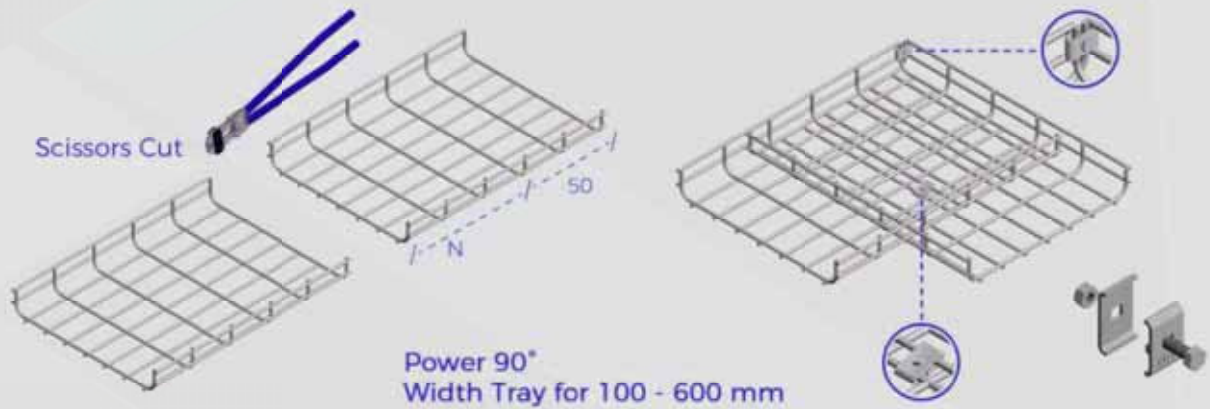

A	100	159	200	300	400	500	600
B	300	400	400	500	600	700	800
N	100	200	200	300	400	500	600

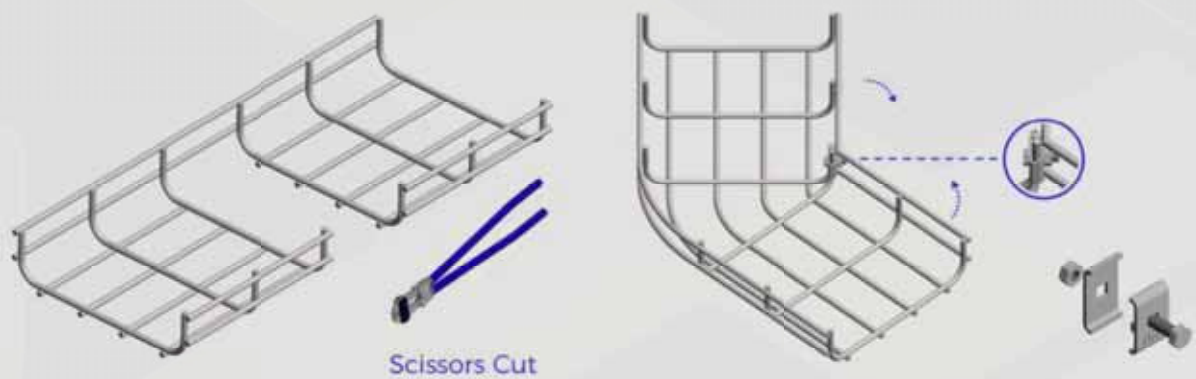



INSTALLATION POWER

WIDTH TRAY FOR
100 - 150 mm

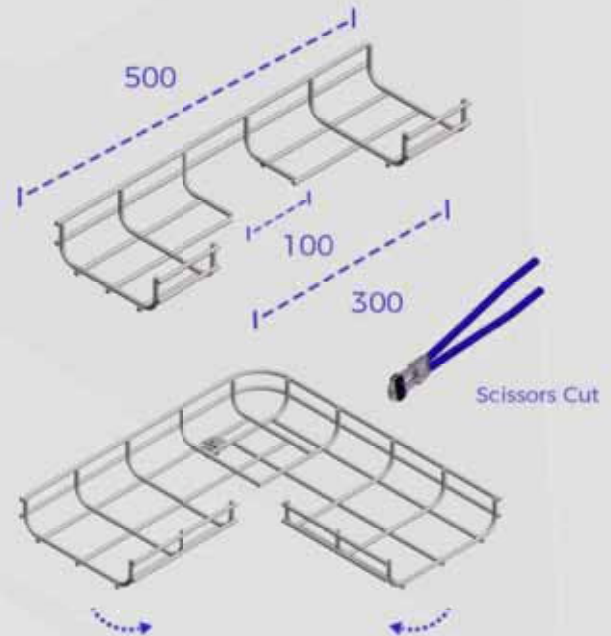
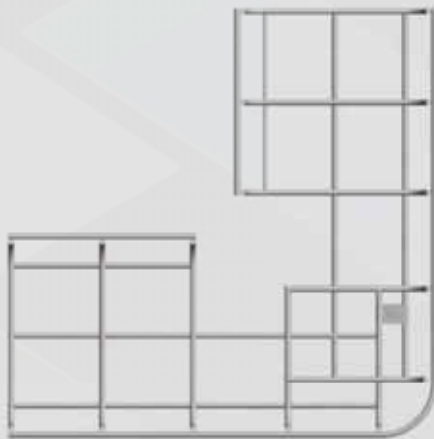

WIDTH TRAY FOR
200 - 600 mm

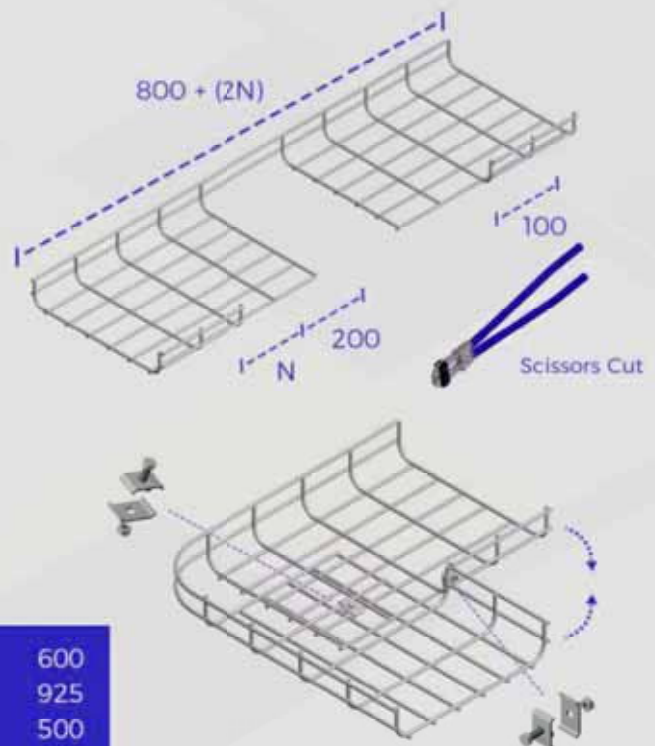
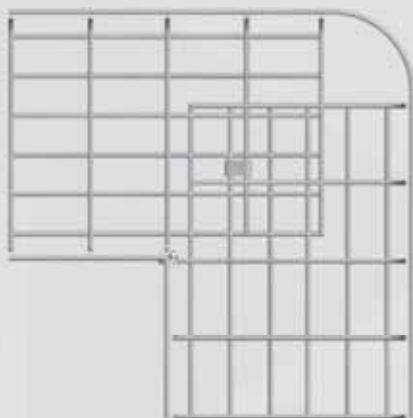

A	200	300	400	500	600
B	525	625	725	825	925
N	100	200	300	400	500



INSTALLATION POWER

WIDTH TRAY FOR
300 - 600 mm

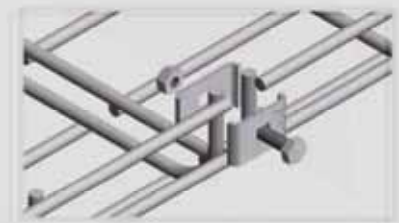
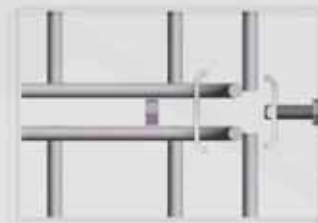

A	300	400	500	600
B	570	840	920	1300
L	1300	1700	2100	2300
X	5	7	9	10

HORIZONTAL SHIF
300 - 600 mm

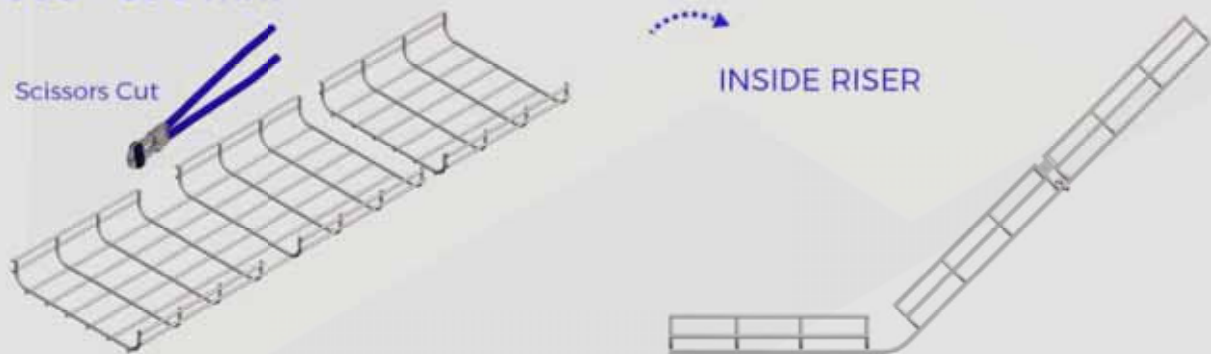



INSTALLATION POWER

EXAMPLE of ASSEMBLY

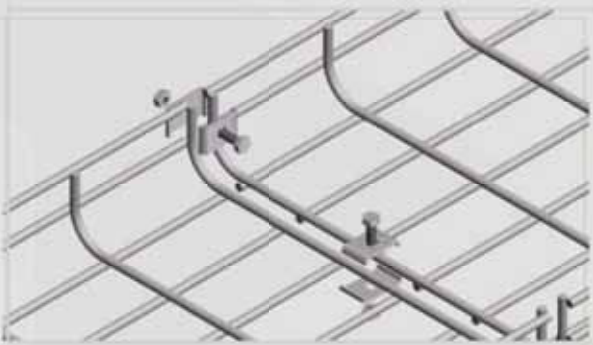
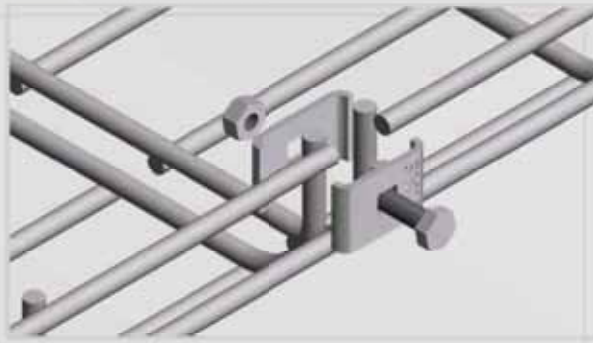
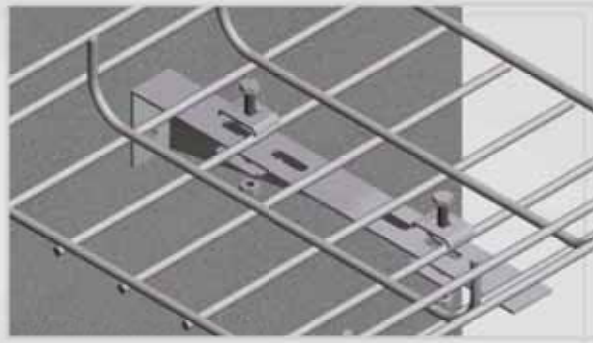



INSTALLATION

REDUCER

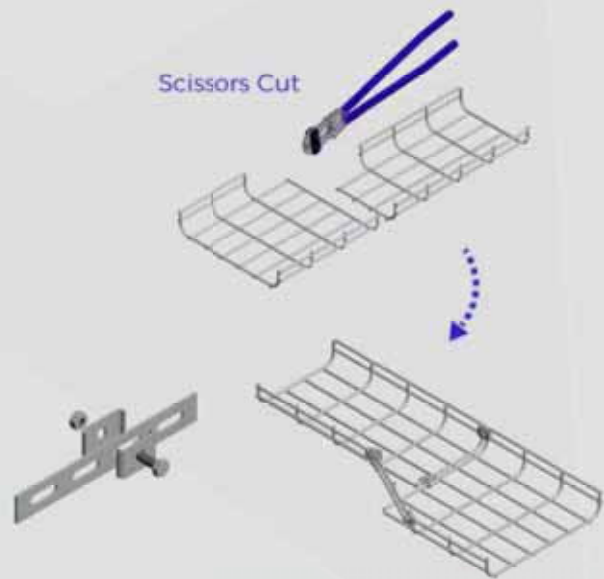
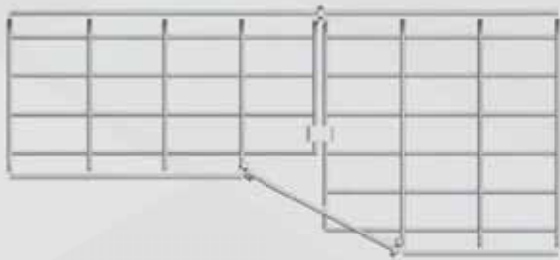

CONNECTIONS TEE

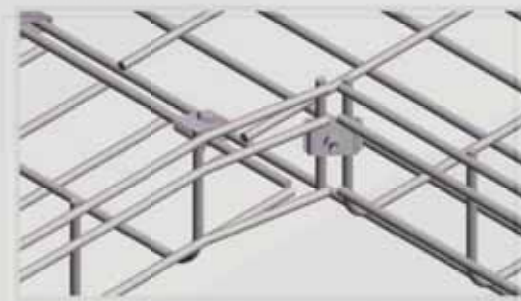
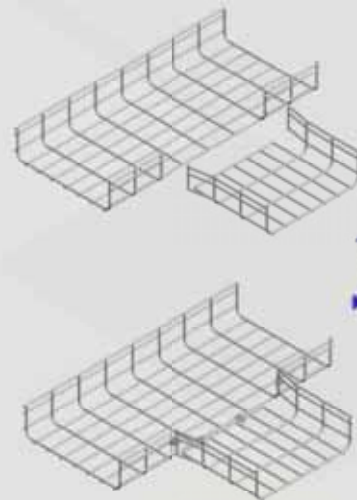

CONNECTIONS TEE
Joiner U20 U30 c/w Bolt Nut



PRODUCT

HOW TO CUT

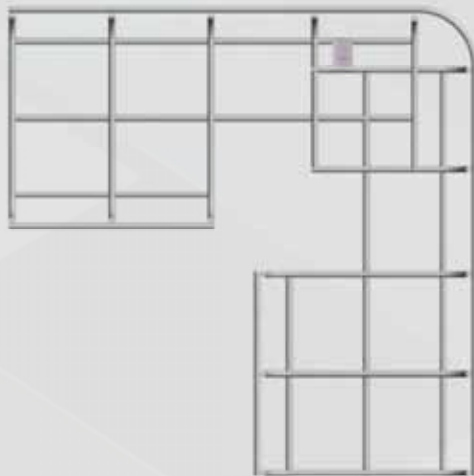

Scissors Cut

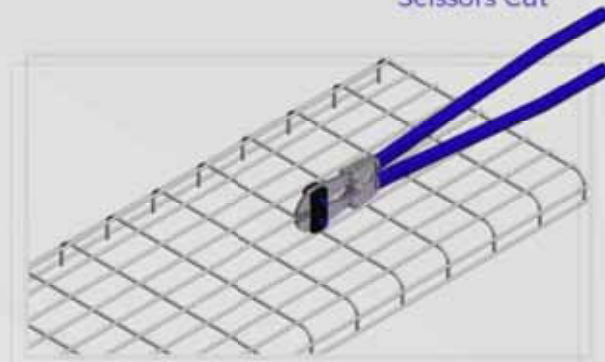

CUT THE MEASUREMENT CONNECTION

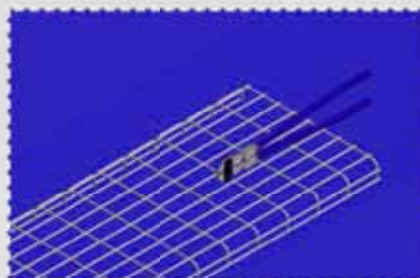
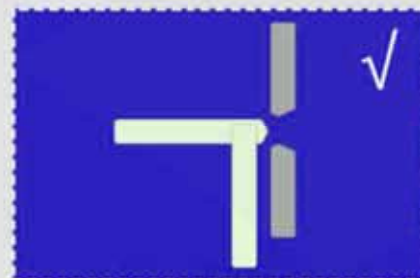
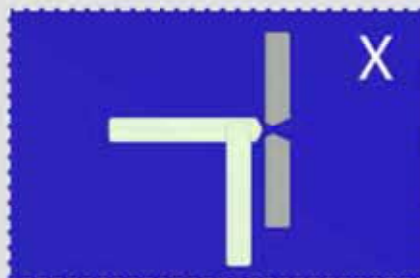

Position Cut



Side Position Cut



PT. ADHIWIRA ELEKTRIKATAMA PERKASA

Alamat: Jl. H. Adam Malik, Lembah Hijau Blok B No. 11
Kreo Selatan, Tangerang, Banten, 15156

Telp/Fax: (021) 7366 7833

Email: adhesa.2021@gmail.com

Website: www.adhiwiraelektrikatamaperkasa.com